

TOONE

TOUCH 02



TOUCH 02

02 Summary
03 Dimensions
04 General instruction
05 Installation instruction
06 Plumbing connection
07 Electrical connection
08 General terms for safe use / Initial Set-Up
09 Machine overview
10 Brewing - Main Brew Head
11 Programming - Main Brew Head
12 Edit recipes
13 Edit recipes
14 Edit recipes
15 Personalize
16 Parameters
17 Calibration
18 Service
19 Service
20 Programming - Side Arm Heads
21 Brewing - Side Arm Heads
22 Brewing - Side Arm Heads
23 Appendix A - Useable Characters
24 Appendix B - Condensed Operations
25 Appendix B - Condensed Operations
26 Cleaning / Descaling
27 Warranty
28 TOUCH 02 - Wiring
29 Technical Data / Declaration / Contact

Dimensions

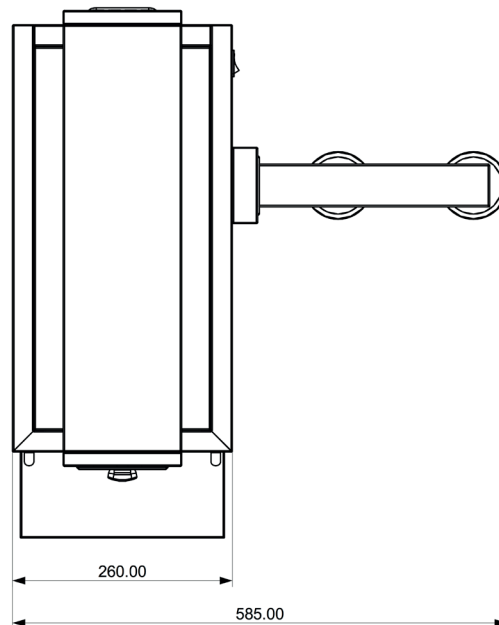
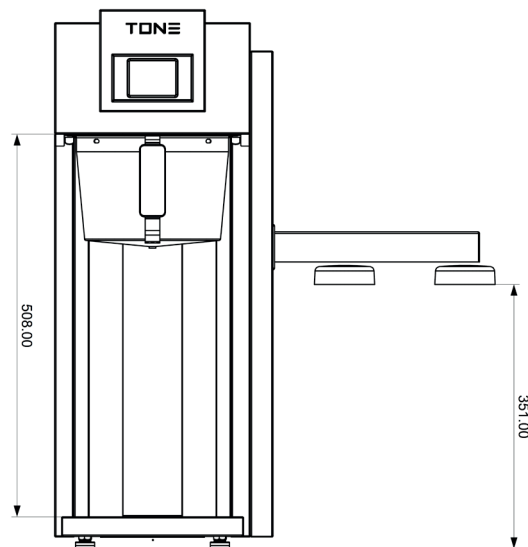
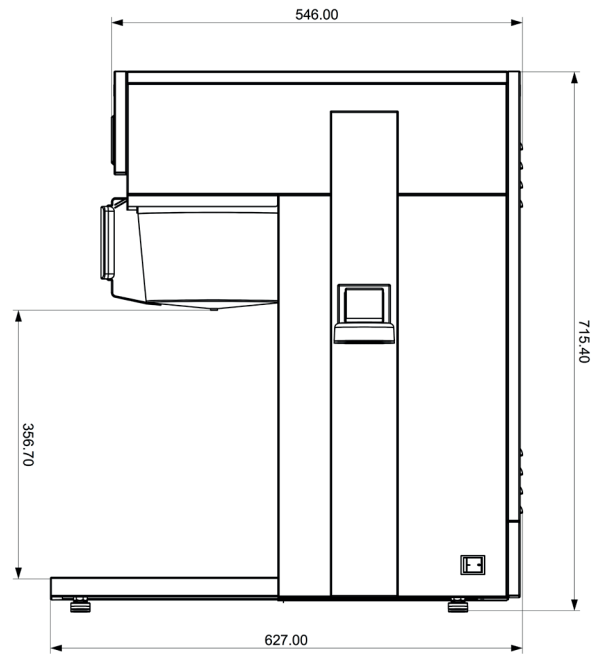

This appliance can be used exclusively by skilled professionals. Avoid the use of this appliance by children or unqualified persons.

This machine shall be destined exclusively to the use it has been expressly designed for. Any other use shall be considered ill-suited and improper. The manufacturer shall not be considered responsible for any damages caused by improper use.

Children shall be supervised and never allowed to play with the appliance.

Children shall be never allowed to clean or maintenance the appliance.

The electric safety of the machine is achieved only when the machine is correctly connected to a grounded electric system.

The user shall arrange electric, water and draining systems in a suitable position to allow correct machine installation.

The installer cannot modify the existing system built by the user.

If the electric supply cable is damaged, it must be replaced by another cable provided by the manufacturer or by its Technical Service.

For good machine functioning and maintenance, it might be necessary to install a water softener in order to avoid scale formation. This must be evaluated by the installer and the user shall leave a space for the correct installation of a water softener, following the instructions contained in its manual.

The machine shall be placed on a surface guaranteeing secure support. The machine must be connected exclusively to an appropriate cold drinking water source, in compliance with national norms and rules.

The pressure of the incoming water must be between 0.138 MPa and 0.620 MPa. If this requirement is not met, consult the manufacturer.

A shut-off tap must be installed between machine water hose and water system to block water flow in case of necessity.

Do not use water jet devices in the area where TONE O2 is installed!

Do **NOT** tilt TONE O2 during operation! Max. tilt angle < 2°.

Only to be operated by trained personnel!

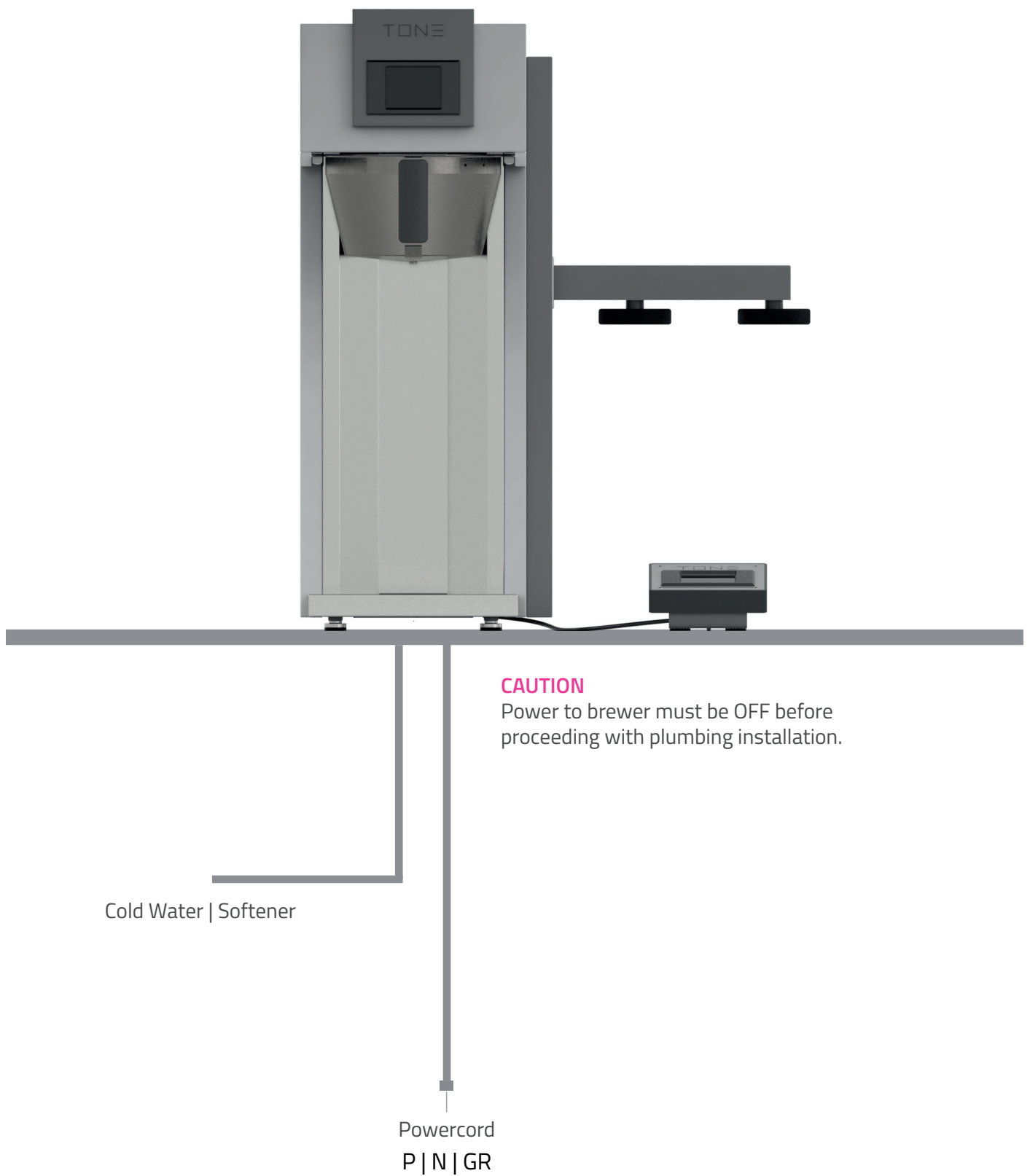

CAUTION

Improper electrical installation will damage electronic components.
Damage caused by incorrect electrical connections is not covered by warranty.

INSTALLATION INSTRUCTIONS

- Brewer should be installed on a secure, level, surface capable of fully supporting the weight of the brewer, including the water retained in the brewer, and any fully loaded dispenser(s) that may be placed on the brewer.
- A potable water line (cold water) capable of consistently supplying the required minimum flow rate within the noted pressure range is required at the install location.
- A grounded electrical connection to a circuit that meets the electrical specifications of the brewer and is protected by the appropriate size and type of breaker is required.

Brewer includes a combination strainer and flow control which **MUST** be attached to the rear plumbing connection. A metal swivel tube assembly is provided for attachment. The fitting plumbing connections are 1/4" male flare. Inclusion of a coil of copper tubing in the water line will allow the brewer to be easily moved for cleaning the counter underneath.

CAUTION:
POWER TO BREWER MUST BE OFF BEFORE PROCEEDING WITH PLUMBING INSTALLATION.

1. Flush water line before installing brewer. Brewer should be connected to **COLD WATER LINE ONLY**.
2. Water pressure should be between 20 psi and 90 psi (.138 MPa and .620 MPa) . For less than a 25 ft run, use 1/4" copper tubing and connect to 1/2" or larger water line. For longer runs, use 3/8" copper tubing & connect to 1/2" or larger water line and provide an adapter fitting for connection to the brewer. Recommended minimum flow rate from water line is 1 gpm measured at the brewer connection point.
3. The use of saddle valves are not recommended as the size and shape of the hole made in the supply line may restrict flow. However, if installed with saddle valve, the valve should have a minimum of 1/8" port hole for up to 25 ft run, and 5/16" port hole for over 25 ft runs.
4. Connect the strainer/flow control (provided) to brewer plumbing connection using the provided swivel tube assembly. Note directional indication on the flow control.
5. Connect incoming water line to the inlet fitting of the strainer/flow control. Manufacturer recommends connecting to copper tubing.

NOTE: If a filter is provided for the brewer, follow the filter manufacturer's recommendations for flushing prior to connecting in line with brewer. Note the brewer has a filter tracking function available in the service menu of the programming module.

WARNING:

The brewer must be disconnected from the power source until specified in INITIAL SET-UP.

CAUTION – Improper electrical installation will damage electronic components. Damage caused by incorrect electrical connections is not covered by warranty.

An electrician must provide electrical service as specified in conformance with all local, state and federal electrical codes.

Use a voltmeter to check the voltage and color coding of each conductor at the electrical source. For models without a cord, remove the rear top cover then the rear panel and feed the cord through the strain relief. Connect cord to the terminal block as indicated in the appropriate diagram above.

Ensure power switch on rear of brewer is in the off position. Connect brewer to power source and verify voltage at terminal block. Replace rear panel and top cover.

If plumbing has been hooked up, brewer is ready for Initial Set-Up. If not, disconnect brewer from power source.

WARNING: Electrical connections must be made as specified above. Failure to follow these instructions can result in personal injury, property or equipment damage.

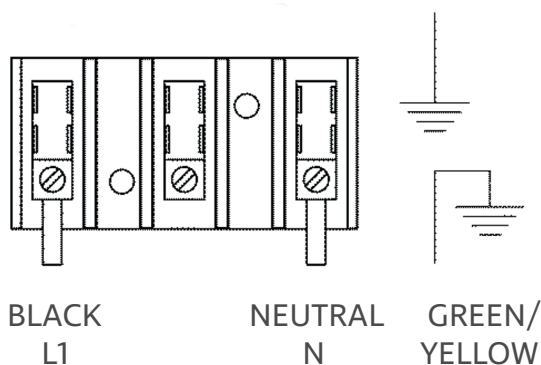

NOTE: This electrical service consist of 2 current carrying conductors (L1 and Neutral) and a separate conductor for earth ground.

WARNING: Before servicing or opening this device make sure the brewer is disconnected from power by pulling its plug. The service technician has to see the pulled plug during the whole service operation.

This machine shall be destined exclusively to the use it has been expressly designed for. Any other use shall be considered ill-suited and improper. The manufacturer shall not be considered responsible for any damages caused by improper use. The electric safety of the machine is achieved only when the machine is correctly connected to a grounded electric system.

This fundamental requirement shall be assessed by qualified personnel. Manufacturer and installer shall not be held responsible for any damages caused by the lack or inefficiency of system grounding.

Some fundamental rules shall be followed when using any electric appliance:

- Do not use the appliance barefoot or when hands / feet are wet.
- Children shall be supervised and never allowed to play with the appliance.
- Unplug the appliance from the electric system and turn off water supply before carrying out any cleaning and ordinary maintenance.
- Do not put the appliance under a jet of water, nor plunge it into water to clean it.
- Do not leave the appliance turned-on and unattended for long periods (e.g. 1 day)
- In order to ensure the efficiency and correct functioning of the appliance, it is necessary to follow the instructions provided by the manufacturer and to carry out its ordinary maintenance.
- The appliance shall be installed so that the highest surface is at least 1 metre high.
- The appliance shall be placed horizontally (use level) by adjusting its feet to ensure a safe use.
- The temperature range of the environment surrounding the appliance shall be included between 5°C and 30°C. In case the appliance is temporarily placed in an environment where the temperature is below 0°C, contact a local Technical Service authorized by the manufacturer.
- When installing the appliance, use exclusively the current set of junctions provided with the appliance itself.
- In case of appliance breakdown and/or malfunctioning, switch it off and refrain from trying to repair it. Then contact a local Technical Service that has been authorized by the manufacturer.

WARNING: Before servicing or opening this device make sure the brewer is disconnected from power by pulling its plug. The service technician has to see the pulled plug during the whole service operation.

If the above-mentioned instructions are not followed, the safety and wear of the appliance can be jeopardized and its guarantee is no longer valid.

This appliance can be used exclusively by skilled professionals. Avoid the use of this appliance by children or unqualified persons. This appliance shall be used only for the use it has been designed for. Any other use shall be considered wrong or unreasonable and therefore the manufacturer shall not be held responsible for any damages caused to persons, animals or things due to a wrong or unreasonable use of this appliance.

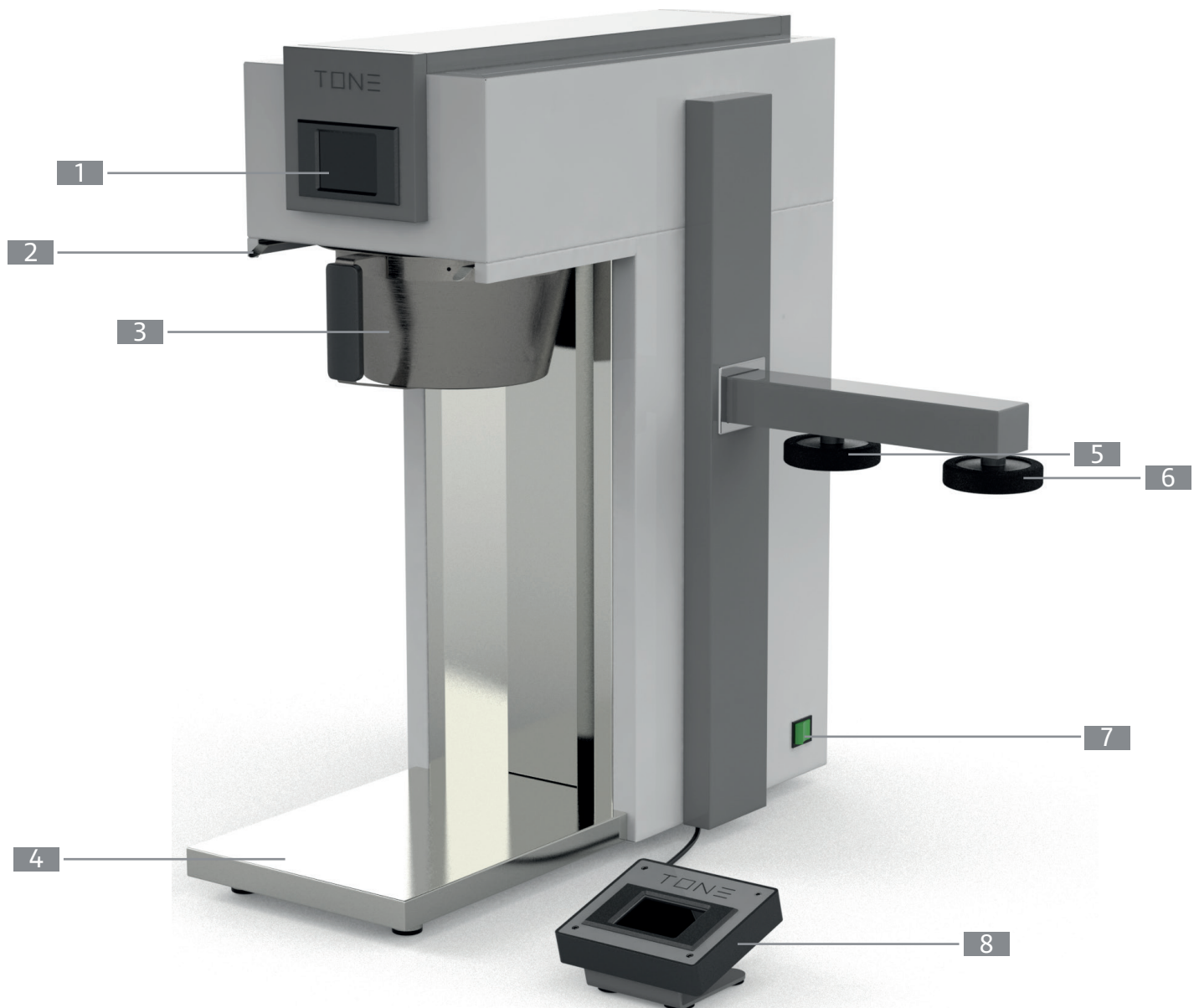

COMPONENTS TOUCH 02

1 | touchscreen

2 | brew rail for basket

3 | brew basket

4 | ground plate

5 | singlebrew arm one

6 | singlebrew arm two

7 | on/off switch

8 | external touch unit

Brewing and Programming Outline

BREWING – Main Brew Head

Place coffee, tea or other product to be brewed into a paper filter within the brew basket and place basket into the holders below the sprayhead.

Place an empty container in place below the basket assuring all applicable brewer dispense points align with vessel opening(s).

Select desired beverage type from the 'beverage selection' screen. If an energy save screen, a FRESH BREWED COFFEE screen, or other screen is displayed, simply touch the screen to return to the 'beverage selection' screen. Selecting beverage type will take you to a 'recipe selection' screen.

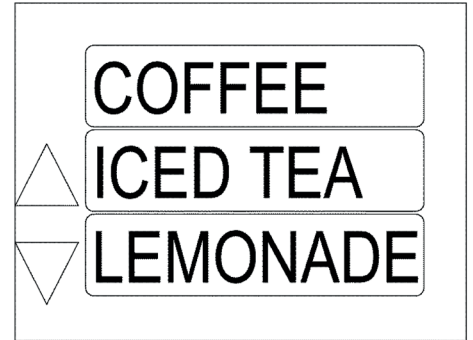

On the 'recipe selection' screen, select the beverage size to be brewed by pressing the appropriate icon key. Various pictorial or descriptive icons will be displayed with the volume of the brew below to help distinguish between recipes. Dependent on the number of active recipes within a beverage type, there may be more than one screen of recipes available. Use the next and previous keys to navigate among multiple screens if applicable. Press return to go back to the beverage selection screen if desired.

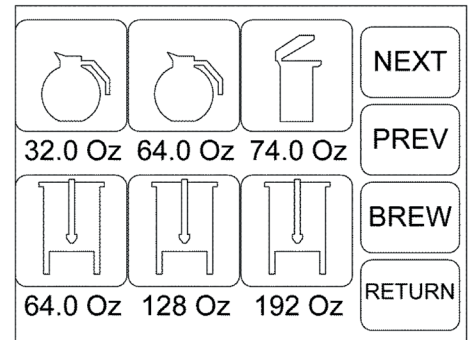

After selecting a recipe to brew, the 'recipe detail' screen will display providing more details for the selected brew.

The 'recipe detail' screen provides summary recipe information for the chosen brew cycle including a recipe name/description, brew volume, time and temperature. Press the brew button to immediately start the brew cycle. Press return to return to the main/standby screen if desired. If unit has been idle for some time, a tank filling screen may display as the tank is refilled. A heating screen will display, if the recipe temperature is set higher than the current tank temperature, while the brewer heats. The brew cycle may be canceled at any point by touching the heating or brewing screen when displayed.

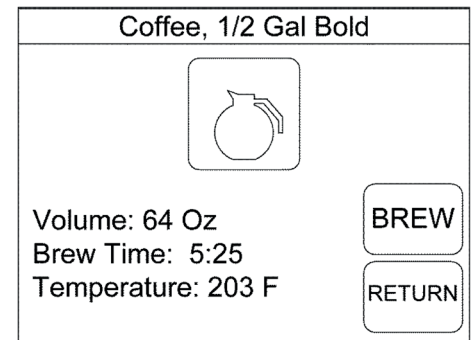

PROGRAMMING – Main Brew Head

To enter programming mode, press the upper left corner (indicated with dashed lines) of the 'beverage selection' screen and hold for 3-4 seconds. A beep will sound if beeper is enabled. Release the touch screen. Many of the steps outlined below are applicable to programming of the side brew arm spray heads. Applicable sections below are the calibration and recipe sections. Other settings are controlled by the main brew head settings.

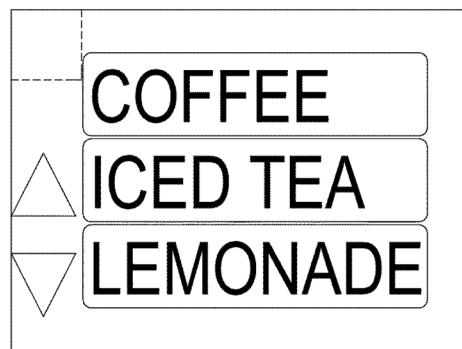

A 'User Password' screen with keypad will be displayed. Type in the 4 digit user password (3650). The entered number will display in the blank area in the upper right side of the screen as you type it. Press enter. CLR will clear entry without exiting the screen. Pressing cancel will exit the screen.

It is not possible to save the user password.

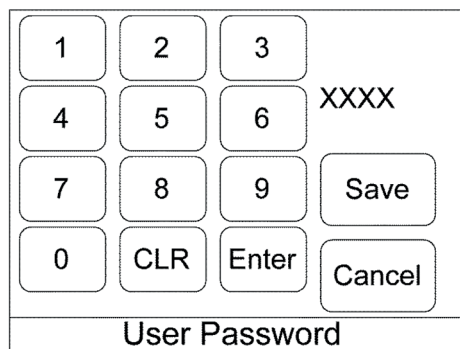

The following screen displays if the incorrect value is entered. Push the large button on the display and you will be returned to the user password screen to try again. Enter the correct password.

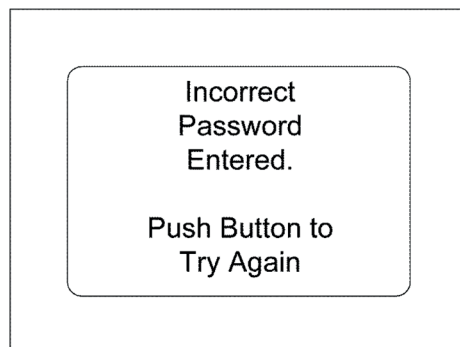

Successful password entry will bring you to the 'Programming/Service' menu screen. These are the categories of programmable options. There are submenus within these items. Pressing Finish returns you to the main selection screen.

EDIT RECIPES

Press Edit Recipes to set active status or to edit recipe information.

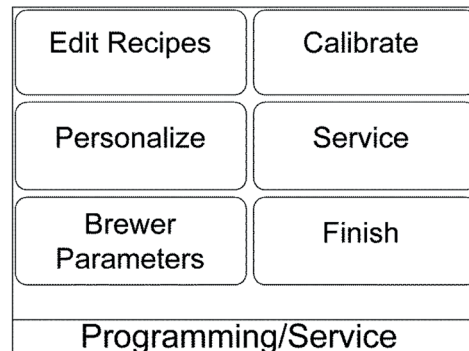

The 'Recipe Select' screen displays "Getting Recipes" while the recipe information is loaded into the display.

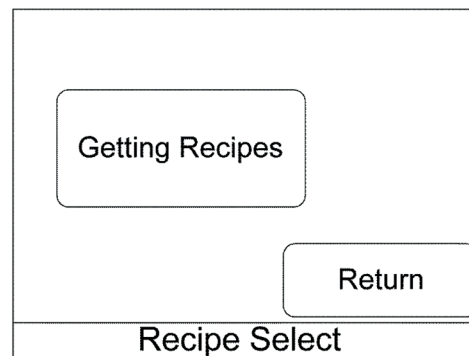

The 'recipe select' screen then shows the recipe names on a rotatable wheel. The selected recipe name displayed in the centrally located target box on the wheel may be changed by either swiping vertically up or down over the recipe name bars or by using the + and - key. When the desired recipe is displayed in the target box, press the "Select Recipe" button.

You will be taken to the 'recipe settings' summary screen for the recipe selected.

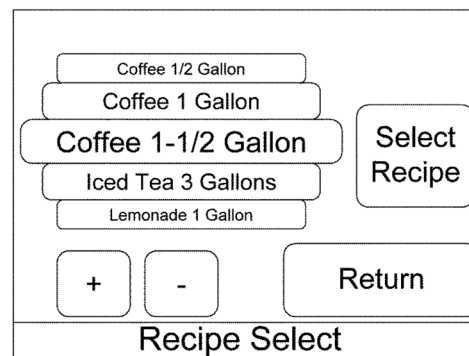

You are now in the 'Recipe Settings' screen for the recipe selected previously. A summary of brew settings is shown on this screen. Pressing one of the brew attribute buttons provides a greater level of detail of the feature and provides access for editing the programmed values. Note: using the + or – on this screen will allow scrolling through all programmed recipes in sequence. This is a convenient way to quickly change status to active or inactive on multiple recipes. Pressing the "Active" button will toggle the status of the recipe between available and not available. A recipe will not be shown on the brew selection screens unless it is set to Recipe Available.

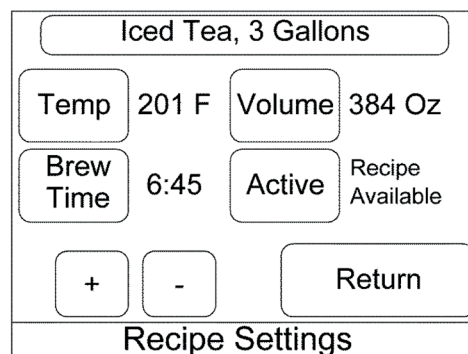

Press the "Temp" key to display the 'Temperature' detail screen. Both the brew temperature and the recipe specific temperature tolerance may be adjusted here. To change either of these two items, first select the item to be adjusted and then use the + and – keys to change value. Note that if autoarm is set to use a global value in the 'Personalize, Other Settings' screen, the temperature tolerance shown on this screen will have no effect. Likewise if autoarm has been disabled on that screen, the setting here will also have no effect. Press return to return to the Recipe Settings screen.

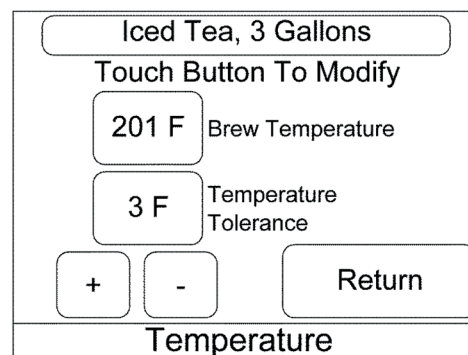

Press the "Volume" key to access the 'Volume' detail screen. Note the multiple volumes associated with the brew cycle are all simultaneously displayed for convenience. Various math checks are done and enable or disable other programming selections based on input. The example recipe below shows a total brew volume of 384 ounces (3 gallons). 80 ounces of that volume will be delivered from the hot water tank through the sprayhead into the brew basket (concentrate). Of the 80 ounce of hot water, 12 ounces will be delivered at the start of the brew cycle as a pre-infusion delivery. A pause between the pre-infusion volume and the continuation of the brew cycle is programmable in the brew time screen. The temperature of the balance (bypass) of the 384 ounces of total brew volume is selected as cold since this is an ice tea recipe. The cold water will be delivered from a separate dispense point and will not go through the basket. There is one brew valve turned on of the two possibly available. This setting will impact allowable brew time since water delivery is different for 1 or 2 brew valves. (Note: 1 valve is normal).

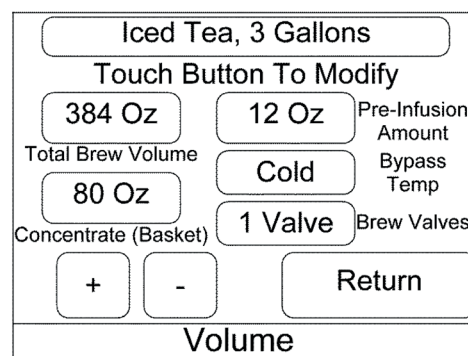

To modify the numeric values shown, first select an item and then use the + and – keys/buttons to change the value. Tap the non-numeric items to toggle through the available choices. When the preferred option is displayed, it is set. Brewers may not have componentry installed for all options. Items will be greyed out if unavailable due to other selections or values. Press return to return to the 'recipe settings' screen.

Brewing and Programming Outline

Press the "Brew Time" button to display the 'brew time' detail screen. Note the multiple times associated with the brew cycle are all simultaneously displayed for convenience. Various math checks are done and enable or disable other programming selections based on input. The pre-infusion pause is the time delay between the completion of the delivery of the pre-infusion volume and the continuation of the hot water delivery through the sprayhead. The concentrate brew time is the total time allowed for hot water to be delivered through the sprayhead. The time may be increased above the calculated minimum time to create a pulse brewing effect. When time is set above the minimum required, the water delivery will cycle on and off throughout the programmed time. The bypass delay is the time delay between completion of the concentrate water delivery and the starting of any bypass water delivery. The delay is only applicable if "After" is displayed as the bypass type for bypass relative to the brew cycle. Before or during are other types of bypass delivery. For a selection of during, the bypass water will be delivered during any concentrate off time available during the concentrate delivery. Note: A recipe made up of entirely cold water dilution (such as for making lemonade from concentrate) would cause all values on this screen to be greyed out as none of the items would be applicable. Press return to return to the 'recipe settings' screen.

Iced Tea, 3 Gallons			
0:10	Preinfusion Pause	After	Bypass Relative to Brew Cycle
3:00	Concentrate Brew Time		
1:00	Concentrate Drip Time	0:30	Bypass Delay
+	-	Return	
Brew Time			

To edit a recipe name, press the recipe name bar near the top of the 'recipe settings' screen. This will take you to the 'edit recipe name' screen. This screen will allow the user to edit the recipe name, set the beverage type, and select an icon to be displayed on the 'recipe selection' screen. To edit the recipe name, select that key/field if it is not already selected. The selected character will begin to blink. Use the L and R button to move the cursor left or right to the letter to be changed. The button above the L and R determines whether an upper case, lower case, or symbol character set will be used. See Appendix A at the end of the document for a listing of the characters and the corresponding group and location within the group. Use the up and down keys to scroll through the various choices available.

Recipe Number 8			
Iced Tea, 3 Gallons			
Set Beverage Type		Set Beverage Icon	
Iced Tea	Select Icon		
Finish	Upper	Up	
Cancel	L	R	Dn
Edit Recipe Name			

Use set beverage type key to select the type of beverage for the recipe. This will determine which category the recipe will be put in on the beverage selection screen. This will ensure all coffee recipes are grouped together as are all iced tea recipes, etc. Each press of the key will display the next choice. Stop when the correct type is displayed for the recipe.

Next use the "Select Icon" key to access icons available to associate with the recipe. The recipes are identified on a 'recipe selection' screen by the icon, along with the beverage volume, so that the user knows which recipe they will be preparing. Icons available will be displayed. Next and Prev Keys are provided to move between the various screens to select an appropriate icon. Select an icon by pressing it. The icon will be highlighted. Once satisfied with the selection, pick finish to return to the 'edit recipe name' screen. Select return to go back to the 'recipe settings' screen then press return again to return to the 'recipe select' screen.

			Next
		Sweet	Prev
mild	medium	bold	Finish

Press return again and the system will exit to the 'programming/service' screen.

PERSONALIZE

At right shows the 'programming/service' screen again. Press the "Personalize" key to go to the 'personalize' screen. 'edit recipes' and 'personalize' screens do not require an additional password.

Edit Recipes	Calibrate
Personalize	Service
Brewer Parameters	Finish
Programming/Service	

The 'personalize' screen allows editing the company name and the phone number displayed when calling for service is required. Changing the user password is disabled and is greyed out. Other settings are available on a separate menu by pressing the "Other Settings" key. To edit the company name, select that field if it is not already selected. The selected character will begin to blink. Use the L and R button to move the cursor left or right to the character to be changed. The button above the L and R determines whether an upper case, lower case, or symbol character set will be used. See the Appendix at the end for a listing of the characters and their corresponding group and location within the group. Use the up and down keys to scroll through the various choices available. To change the phone number, select the phone number.

Newco Enterprises			
<small>Company Name</small>			
636-925-1202			
<small>Call for Service Phone Number</small>			
User Password	Other Settings		
Finish	Upper	Up	
Cancel	L	R	Dn
Personalize			

A 'service telephone number' screen with keypad will be displayed. Key in the service area code and phone number. Press Save to store the service telephone number. CLR will clear entry without exiting the screen. Cancel will exit the screen without saving changes and return you to the 'personalize' screen shown above.

1	2	3	
4	5	6	
7	8	9	Save
0	CLR	Enter	Cancel
Service Telephone Number			

Brewing and Programming Outline

Select "Other Settings" to go to the 'personalize, other settings' screen. Note: Multiple languages are not available. Imperial or Metric measurement units may be chosen. If imperial is selected, volume will be programmed in fluid ounces and temperature in degrees Fahrenheit. If Metric measure is chosen volume will be programmed in milliliters and temperature in degrees Celsius. The end of cycle/keypad beeper may be set to on or off. The energy save mode has three choices: No energy saver, energy saver, or power off. No energy saver maintains normal tank temperature based on the lowest temperature setting of the active recipes. Energy saver mode will set back the temperature that the tank is maintained at and power off will shut down the tank heater. The selected action will take place when the "Setback After" time has been reached. Use the + and – keys to change the setback time. The autoarm key may be used to choose autoarm on, autoarm off, or autoarm global. If autoarm on is chosen, the individual recipe tolerances will be used to determine if the tank is hot enough to start a brew cycle. If autoarm global is selected, the value programmed on this screen will be used for all recipes, regardless of a tolerance set in the individual recipes. Tap the autoarm tolerance key to increment the tolerance value to the desired setting. Press finish to return to the personalize screen and then press finish to return to the programming/service screen.

English	Setback After	+
Imperial Measure	0.0	-
EOC Beeper - On	Hours	
No Energy Saver	Autoarm On	
Finish		3 F
Personalize, Other Settings		

PARAMETERS

The 'brewer parameters' screen is meant for factory settings. Contact factory for password authorization for these settings. Press the "Brewer Parameters" key to go to the 'brewer parameters' screen. This screen is designed to allow the technician to tell the control board how the machine has been configured or to disable certain features that may be installed. Touch the various keys to cycle through the available options and select the one that is appropriate for your installation. Brew valve choices are for one or two brew valves. If two valves are selected, one or both may be activated for a particular brew cycle. This is not a common configuration and does not include the hot water bypass valve. Hot bypass and cold dilution may be set to installed or not installed. A hotwater dispense valve may be installed for controlling a faucet or other hot water dispense outlet. Recipes may then be set to deliver premeasured volumes of hot water. Push and hold feature is automatically available when not brewing when a hot water valve dispense valve is installed. The heating circuit may be programmed for either a solid state device which would allow pulse heating, or for a mechanical relay, which would not but would be a more economical choice. Warning – running a mechanical relay in pulsing mode will lead to premature failure of the component. Press return to return to the programming/service screen.

1 Brew Valve	205 F	MAX SETPOINT
Hot Bypass Installed	Hot Dispense Not Installed	
Cold Dilution Installed	Relay No Pulsing	
Return	+	-
Parameters		

CALIBRATION

Press the calibrate key. A 'calibration Password' screen with keypad will be displayed. Type in the 4 digit service password (3926). The number will display in the blank area in the upper right side of the screen as you type it. Press enter. CLR will clear entry without exiting the screen. Pressing cancel will exit the screen.

1	2	3	
4	5	6	XXXX
7	8	9	Save
0	CLR	Enter	Cancel
Calibration Password			

The calibrate screen will display. Items that are not installed or that have been disabled in the parameters section will be greyed out. Other items may be calibrated to ensure brewing accuracy. Only the items for which calibration is desired need be addressed.

Brew Valve 1	Cold Dilution Valve
Brew Valves 1 & 2	Hot Dispense Valve
Hot Bypass Valve	Finish
Calibrate	

NOTE FOR TECHIES – Due to inaccuracies inherent in some graduated measurement vessels, weighing the water dispensed can be a more accurate method to determine volume dispensed. Water density varies with temperature however. If weighing in ounces, water is closest to a 1 to 1 ratio of ounces in weight to fluid ounces at brewing temperatures (190–205F). It is safe to say for hot water dispensing that 1 oz weight on scale is (nearly) equal to 1 fluid ounce of volume. Cooler water is denser however so a fluid ounce of water dispensed at ambient temperatures will weigh more than an ounce, about 1.04 ounces weight. A fluid ounce of water will weigh approximately 0.96 ounces so multiplying the scale weight by .96 will yield the volume in fluid ounces. If using the metric measurement system, water weight and volume will be closer to unity at room temperature in regards to grams and milliliters. At brew temperatures, a scale reading in grams should be multiplied by 1.04 to get volume in milliliters.

Brewing and Programming Outline

Press "Brew Valve 1" to enter the 'calibrate brew 1' screen for brew valve one. A countdown clock for the calibration interval is located in the upper right of the screen. The currently programmed volume for this time frame is located immediately below. The + and – keys are used to adjust this value. Place a suitable container in place below the dispense outlet being calibrated. Press the start key and a timed dispense will start. Heating may be required dependent on tank temperature. The dispense cycle may be stopped if needed by pushing the stop key. The cycle may be started again without exiting the screen. The water collected from a complete calibration dispense cycle should be measured and the value entered on this screen. Running multiple cycles and using a weighted average will yield best results. Press the finish key to return to the 'calibrate' screen. The above process may be repeated for each installed item to ensure proper programmed volumes will be dispensed when brewing. Options that are not installed or that have been disabled in the "Parameters" section, will be greyed out. Possible items that may be available for calibration are: Brew Valves 1 & 2, Hot Bypass, Cold Dilution, and Hot Dispense valves. Run time may vary for the various items. Press finish key to return to the Calibrate screen after finishing with each item.

Brew Valve 1			
Start	1:00		
Stop	44.5 Oz	Adjust to Volume	
Finish	+	-	
Calibrate Brew 1			

SERVICE

Press the "Service" key. A 'service password' screen with keypad will be displayed. Type in the 4 digit service password (3926). The number will display in the blank area in the upper right side of the screen as you type it. Press enter. CLR will clear entry without exiting the screen. Pressing cancel will exit the screen.

1	2	3	
4	5	6	XXXX
7	8	9	Save
0	CLR	Enter	Cancel
Service Password			

The 'service' menu is displayed once the password is successfully entered.

Error Messages	Filtration
Counters	Service Password
Finish	
Service	

Press "Error Messages" to display a historical list of error messages. Some errors may be intermittent due to various conditions and do not necessarily cause the brewer to shut down. Press "Reset Errors" to reset the error count to zero. Press finish to return to the service screen.

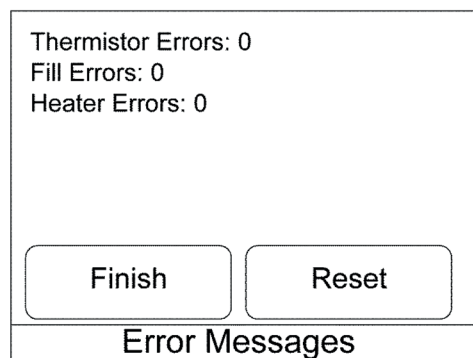

Press the "Counters" key to display the 'counters' screen. The total cycles and gallons are non-resettable. Press the "Reset Service Cycles" to reset the other counters. Press the finish key to return to the 'service' screen.

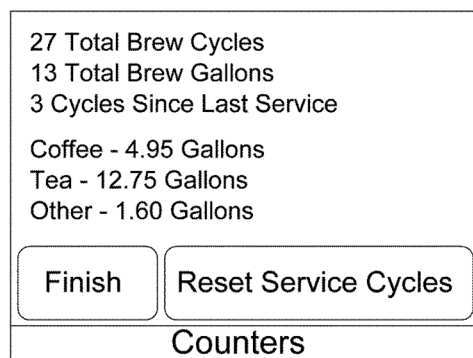

Press the "Filtration" key to enter the "Filtration" screen. Press the top left button to cycle between the various selections for the filter size or use the + and - keys. Press the "Reset Filter" key to reset the filter capacity. Press finish to return to 'service' screen.

The service password is fixed and may not be changed and is greyed out.

Press finish again to return to the 'programming/service' screen. Then select finish to exit programming.

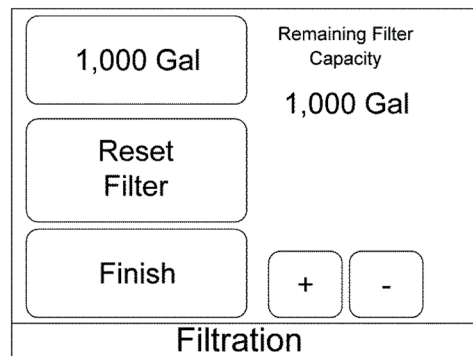

PROGRAMMING – Sidearm Spray Heads

Programming for the brewer sidearm sprayheads is done in much the same manner as for the main brewer. The 2 sprayheads are denoted as Font 1 and Font 2. Font 1 is the sprayhead located closest to the main brewer body, on the left side of the arm. Font 2 is the out board sprayhead located to the right. Calibration and recipes are programmed individually for each font. To enter programming mode, press the upper left corner or right corner (indicated with dashed lines) of the 'beverage selection' screen and hold for 3-4 seconds. The corner to press is dependent on which font you wish to program. A beep will sound if beeper is enabled. Release the touch screen.

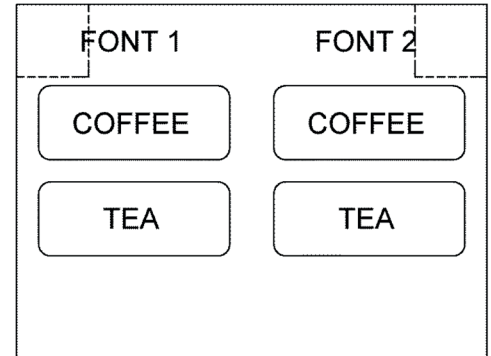

A 'User Password' screen with keypad will be displayed. Type in the 4 digit user password (3650). The entered number will display in the blank area in the upper right side of the screen as you type it. Press enter. CLR will clear entry without exiting the screen. Pressing cancel will exit the screen.

It is not possible to save the user password.

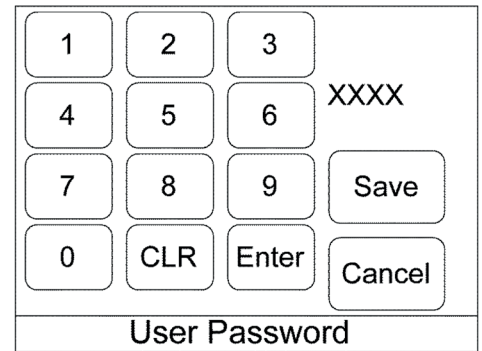

Successful password entry will bring you to the 'Programming/Service' menu screen. These are the categories of programmable options. There are submenus within these items. Pressing Finish returns you to the main selection screen. For the sidearm, only two choices will be available. These are the edit recipes and calibrate options. The instructions outlined for the main brewer will provide an explanation of how to use these program selections. Please refer to the relevant sections on the preceding pages.

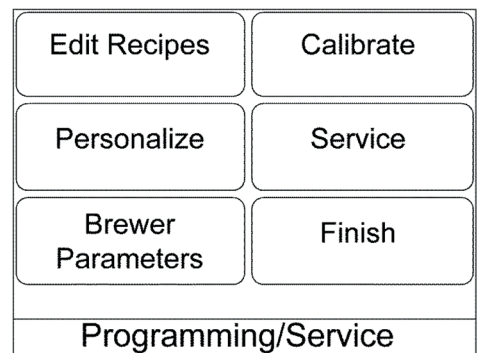

BREWING – Sidearm Spray Heads

Place coffee, tea or other product to be brewed into appropriate holder and position with the proper associated vessel below the sprayhead to be used for brewing. Select desired beverage type from the 'beverage selection' screen for the appropriate font. Selecting a beverage type will take you to a 'recipe selection' screen with available recipes for that beverage type.

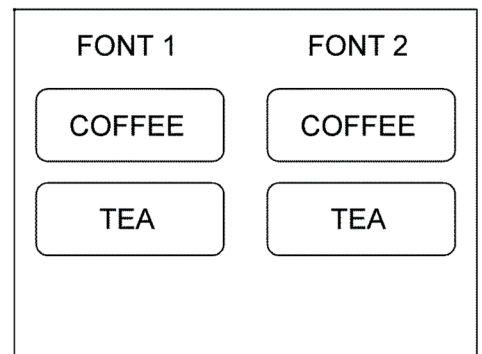

On the 'recipe selection' screen, select the beverage size to be brewed by pressing the appropriate icon key. Various pictorial or descriptive icons will be displayed with the volume of the brew below to help distinguish between recipes. Dependent on the number of active recipes within a beverage type, there may be more than one screen of recipes available. Use the next and previous keys to navigate among multiple screens if applicable. Press return to go back to the beverage selection screen if desired. After selecting a recipe to brew, the 'recipe detail' screen will display providing more details for the selected brew.

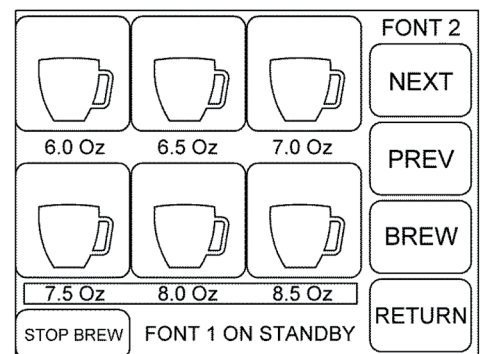

The 'recipe detail' screen provides summary recipe information for the chosen brew cycle including a recipe name/description, brew volume, time and temperature. Press the brew button to immediately start the brew cycle. Press return to return to the main/standby screen if desired. Note that the upper right corner is used to indicate which font you are preparing to brew on. The lower portion of the screen indicates the current status of the other font which may be on standby or brewing. If the other font is brewing, the "Stop Brew" button may be used to stop the brew if desired without leaving the current screen.

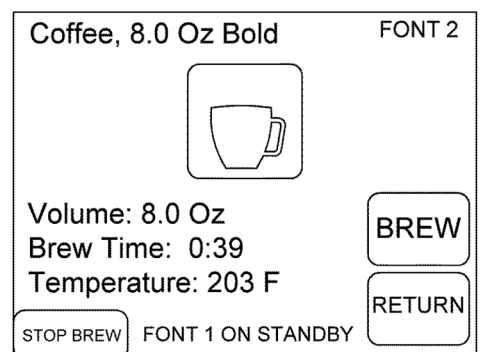

Brewing and Programming Outline

The screen at right shows a brew in process on Font 2 while Font 1 is idle. The "Stop Brew" key may be used to cancel the brew on Font 2. A brew process could be started on Font 1 without disrupting the brew on Font 2 if desired.

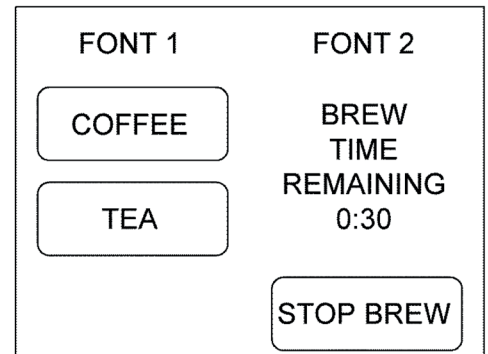

The screen at right provides the last brew information for Font 2 while simultaneously counting down the remaining brew time for Font 1. The "Stop Brew" key may be used to cancel the brew on Font 1. The "Return To Menu" key on the Font 2 side of the display will cancel the last brew time display and allow another recipe to be selected and brewed.

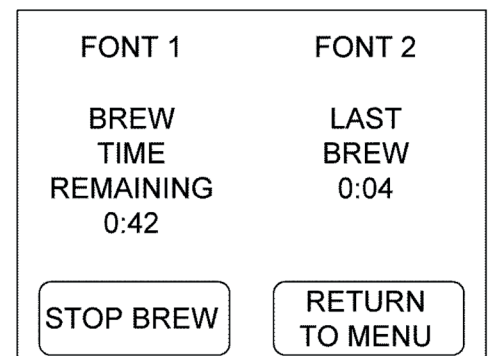

The screen at right provides the last brew information for fonts 1 and 2. The "Return To Menu" key(s) will cancel the last brew time(s) and allow another recipe to be selected and brewed.

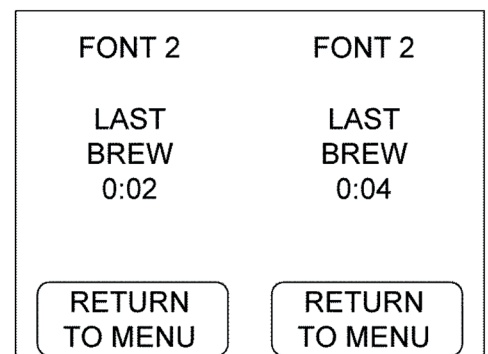

Appendix A - Useable Characters

Useable Characters for Recipe and Company Names

Group	Character	Group	Character	Group	Character
Symbol		Upper	A	Lower	a
Symbol	!	Upper	B	Lower	b
Symbol	“	Upper	C	Lower	c
Symbol	#	Upper	D	Lower	d
Symbol	\$	Upper	E	Lower	e
Symbol	%	Upper	F	Lower	f
Symbol	&	Upper	G	Lower	g
Symbol	'	Upper	H	Lower	h
Symbol	(Upper	I	Lower	i
Symbol)	Upper	J	Lower	j
Symbol	*	Upper	K	Lower	k
Symbol	+	Upper	L	Lower	l
Symbol	,	Upper	M	Lower	m
Symbol	-	Upper	N	Lower	n
Symbol	.	Upper	O	Lower	o
Symbol	/	Upper	P	Lower	p
Symbol	0	Upper	Q	Lower	q
Symbol	1	Upper	R	Lower	r
Symbol	2	Upper	S	Lower	s
Symbol	3	Upper	T	Lower	t
Symbol	4	Upper	U	Lower	u
Symbol	5	Upper	V	Lower	v
Symbol	6	Upper	W	Lower	w
Symbol	7	Upper	X	Lower	x
Symbol	8	Upper	Y	Lower	y
Symbol	9	Upper	Z	Lower	z
Symbol	:	Upper	[Lower	{
Symbol	;	Upper	\	Lower	
Symbol	<	Upper]	Lower	}
Symbol	=	Upper	^	Lower	~
Symbol	>	Upper	_	Lower	-
Symbol	?	Upper		Lower	

BREWING

Insert funnel with product to brew as applicable. Ensure empty dispenser in place below brew head.
Touch screen to wake brewer if necessary.
Select beverage type from choices.
Select brew volume from choices.
Press the brew button to immediately start brew cycle.

ENTER PROGRAMMING

Press the upper left hand corner of main beverage type selection screen. Enter password – (3650).

EDIT RECIPE

Enter programming (see "ENTER PROGRAMMING").
Select "Edit Recipes".
Select recipe to be edited (use + or – on either scrolling wheel or summary "Recipe Settings" screen).
Select feature to be modified from summary screen: Temp, Volume, or Time.
Adjust feature parameters on detail screens. Push return to return to summary Recipe Settings screen.
Press return to go back to "Recipe Select" screen. Press return again to go back to the Programming/Service menu.
Select finish when editing is completed. Press Finish again to return to the main/beverage select screen.

PERSONALIZE

Enter programming (see "ENTER PROGRAMMING").
Select "Personalize".
User may edit phone number by selecting the phone number and using keypad and save function. The company name may be edited using the L,R keys to select letter to be changed. Then use Up/Down keys to change letter. Change between symbols and upper and lower case letters using key above the L and R keys.
Select other settings to turn on/off beeper or energy modes. A setback time may be programmed for energy saving options and Autoarm options may be activated or disabled. Metric or imperial measure may be selected here also.
Password is non-changeable.
Press finish to go back to the Programming/Service menu. Press Finish again to return to the main screen.

CALIBRATE

Enter programming (see "ENTER PROGRAMMING").
Select "Calibrate". Enter password – (3926).
Select item to be calibrated (greyed out items are not available for calibration. May not be installed or have been turned off in "Brewer Parameters" section).
Countdown clock is displayed with current setting. Place container in place at outlet to be calibrated. Press start. Measure volume. Adjust the programmed value if required. (Dependent on conditions, it may be advisable to run multiple cycles and enter weighted average).
Press Finish. If no further items require calibration select Finish again to go back to the Programming/Service menu. Press Finish again to return to the main/beverage select screen.

SERVICE

Enter programming (see "ENTER PROGRAMMING").

Select "Service". Enter password – (3926).

Select Error Messages to display and reset error messages. Press Finish to return to Service Menu. Press the Counters key to view water usage and number of cycles information. Service cycles may be reset. Press Finish to return to Service Menu.

Press Filtration to activate or reset filter tracking. Filter capacity may be selected from sizes commonly used in the beverage industry. Press Finish to return to Service Menu.

Password is non-changeable.

Press finish to go back to the Programming/Service menu. Press Finish again to return to the main/beverage select screen.

BREWER PARAMETERS

This section of the code provides access to enable configuration of the brewer according to the options installed during equipment manufacture.

Selections made in this section determine items available for calibration and for use in a brew recipe. Note that inaccurate selections made in this portion of the code can create the appearance of equipment malfunction and therefore the password for this section will not be provided in the instructions with the equipment.

Enter programming (see "ENTER PROGRAMMING").

Select Brewer Parameters and enter password – (5639).

All choices shown may be changed by repeatedly touching the appropriate button until the correct option is displayed. 1 or 2 brew valves may be selected. Recipes may then specify using 1 or both valves and calibration is allowed for both choices.

Hot Bypass may be set as installed or not installed. Setting as installed allows use of hot water bypass in recipes and allows calibration of the valve. If turned on without an actual valve, recipe would be short any programmed bypass.

Cold Dilution may be set as installed or not installed. Setting as installed allows use of cold water bypass in recipes and calibration of the valve. If turned on without an actual valve, recipe would be short any programmed bypass.

Hot dispense valve is for using a hot water valve to control dispensing pre-measured volumes of hot water. A push and hold feature is automatically enabled when this feature is selected.

The heating circuit may be programmed for either a solid state device which would allow pulse heating or for a mechanical relay which would not but would be a more economical choice.

Press finish to go back to the Programming/Service menu. Press Finish again to return to the main/beverage select screen.

DAILY CLEANING

To guarantee proper functionality of TONE equipment it is necessary to clean the device on each day.

To clean the surface of TONE equipment is recommended to use a damp cloth rinsed in liquid detergent.

Do **NOT** use water jet device clean this equipment with a water jet device.

Check and clean each sprayhead daily. All sprayhead holes must always remain open.

NOTE - Any remains on the sprayhead may influence the water flow and impact your coffee brewing.

- Place a fresh filter into brew basket and add appropriate amount of sanitizer.
- Place thermal server in place and initiate a brew cycle to fill dispenser.
- After cycle has finished, allow to sit for several minutes.
- Draw cups of cleaner through dispenser to ensure cleaner reaches all parts of dispenser.
- Rinse the brew basket and thermal server with fresh water, again drawing water through dispenser.
- Discard any remaining water and you are ready to brew.

DESCALING

To guarantee proper functionality of TONE equipment it is necessary to descale the device each year, independent of using a water softener.

TONE Kaffeemaschinen AG recommend to execute the first descaling after one year after installation.

Descaling of TONE equipment only by qualified personnel.

To descale your TONE equipment, please contact a local Technical Service that has been authorized by the manufacturer.

To find out your local Technical Service visit our website or call our Hotline **+41 52 620 06 06**.

TONE Kaffeemaschinen AG warrants equipment manufactured by it for 1 year parts and labor.

Accessories and Dispensers 1 Year parts only.

Electronic Circuit and Control Boards- 2 years parts, 1 year labor.

Equipment manufactured by others and distributed by TONE - Please see original equipment manufacturers warranty, TONE Kaffeemaschinen AG will follow.

These warranty periods run from the date of sale. Newco warrants that the equipment manufactured by it will be commercially free of defects in material and workmanship existing at the time of manufacture and appearing within the applicable warranty period. This warranty does not apply to any equipment, component or part that was not manufactured by Newco or that, in Newco's judgment, has been affected by misuse, neglect, alteration, improper installation or operation, relocation or reinstallation, improper maintenance or repair, incorrect voltage applied to the unit at any time, damage or casualty. This warranty does not apply to any equipment failures related to poor water quality, excessive lime and chlorine and non periodic cleaning and descaling. Warranty is null and void if muriatic or any other form of hydrochloric acid is used for cleaning or deliming. In addition, this warranty does not apply to replacement of items subject to normal use including but not limited to user replaceable parts such as faucet seat cups, sight gauge tubes, washers, o-rings, tubing, seals and gaskets.

This warranty is conditioned on the Buyer 1) giving TONE Kaffeemaschinen AG prompt notice of any claim to be made under this warranty by telephone at +41 52 620 06 06 or by mail to contact@tone-swiss.com; 2) if requested by TONE Kaffeemaschinen AG, shipping the defective equipment prepaid to an authorized TONE Kaffeemaschinen AG service location; and 3) receiving prior authorization from TONE Kaffeemaschinen AG that the defective equipment is under warranty.

THE FOREGOING WARRANTY IS EXCLUSIVE AND IS IN LIEU OF ANY OTHER WARRANTY, WRITTEN OR ORAL, EXPRESS OR IMPLIED, INCLUDING, BUT NOT LIMITED TO, ANY IMPLIED WARRANTY OF EITHER MERCHANTABILITY OR FITNESS FOR A PARTICULAR PURPOSE. The agents, dealers or employees of Newco are not authorized to make modifications to this warranty or to make additional warranties that are binding on TONE Kaffeemaschinen AG. Accordingly, statements by such individuals, whether oral or written, do not constitute warranties and should not be relied upon.

If TONE Kaffeemaschinen AG determines in its sole discretion that the equipment does not conform to the warranty, TONE Kaffeemaschinen AG, at its exclusive option while the equipment is under warranty, shall either 1) provide at no charge replacement parts and/or labor (during the applicable parts and labor warranty periods specified above) to repair the defective components, provided that this repair is done by a TONE Kaffeemaschinen AG Authorized Service Representative; or 2) shall replace the equipment or refund the purchase price for the equipment.

THE BUYER'S REMEDY AGAINST TONE KAFFEEMASCHINEN AG FOR THE BREACH OF ANY OBLIGATION ARISING OUT OF THE SALE OF THIS EQUIPMENT, WHETHER DERIVED FROM WARRANTY OR OTHERWISE, SHALL BE LIMITED, AT NEWCO'S SOLE OPTION AS SPECIFIED HEREIN, TO REPAIR, REPLACEMENT OR REFUND.

In no event shall TONE Kaffeemaschinen AG be liable for any other damage or loss, including, but not limited to, lost profits, lost sales, loss of use of equipment, claims of Buyer's customers, cost of capital, cost of down time, cost of substitute equipment, facilities or services, or any other special, incidental or consequential damages.

WIRING DIAGRAM

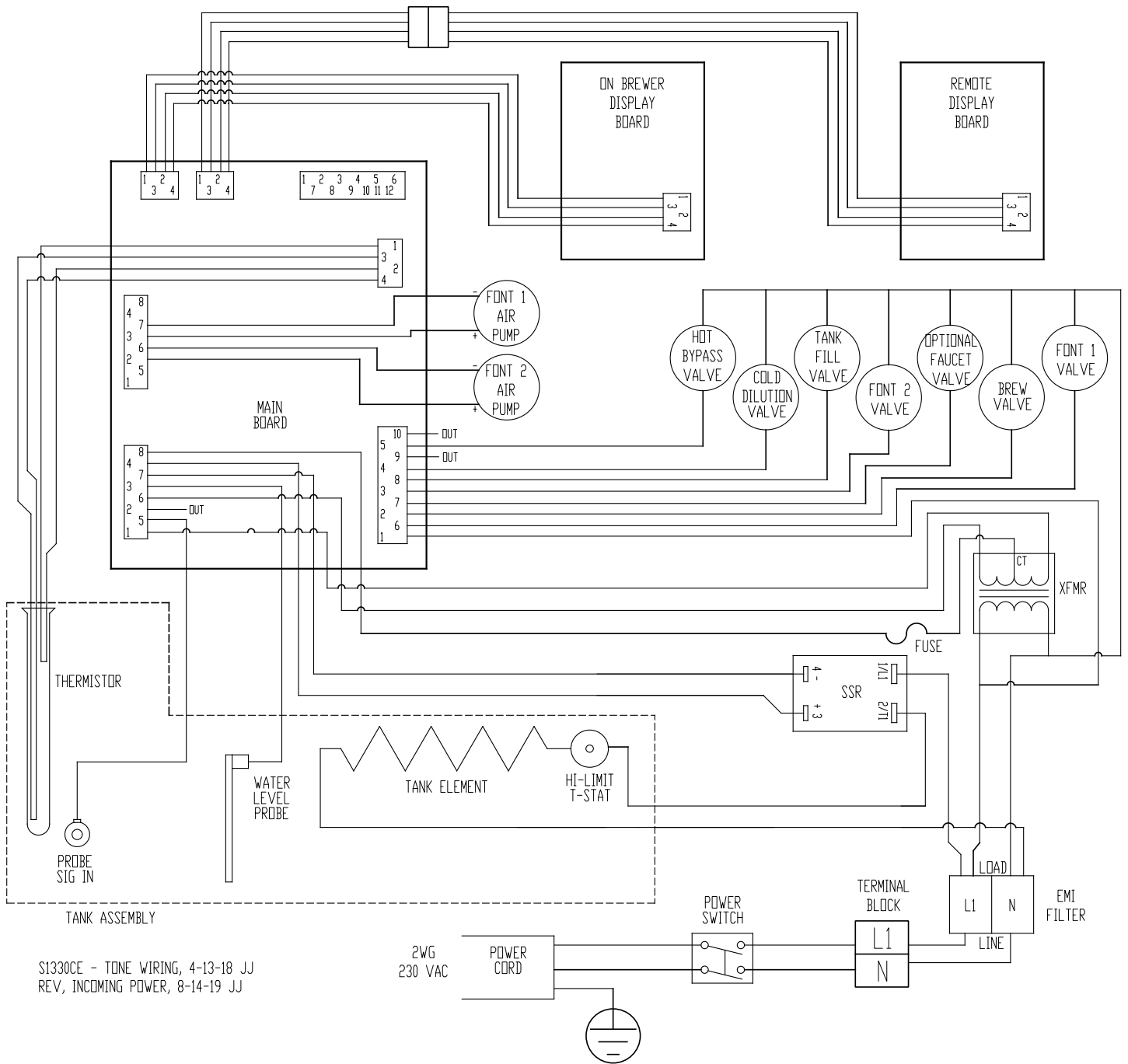

S1330CE - TONE WIRING, 4-13-18 JJ
 REV, INCOMING POWER, 8-14-19 JJ

TECHNICAL DATA

Type	TOUCH 02
Dimensions in mm (w x h x d)	585 x 715 x 627
Weight	34 kg
Power	~ 220 - 240V 50/60Hz
Boilervolume	9 liters
Minimal Waterpressure	0,138 MPa
Maximal Waterpressure	0,620 MPa
Heating	2850W
Noise level	< 70 dB

EEC CONFORMITY DECLARATION ACT 2006/42/EC

The undersigned: TONE Kaffeemaschinen AG
With premises at: Rheinweg 4, 8200 Schaffhausen, Switzerland

Declares that:

The coffee machine has been projected and manufactured in conformity with Directive 2006/42/EC and relevant national law, in accordance with the following norm for conformity evaluation: UNI 9887, ISPSEL rev. 95.

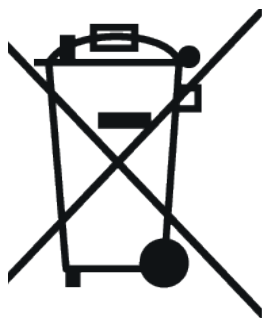

INFORMATION FOR CORRECT DISPOSAL OF THE PRODUCT IN ACCORDANCE WITH EC DIRECTIVE 2012/19/EU

This product must not be disposed of as urban waste at the end of its working life. It must be taken to a special waste collection centre licensed by local authorities or to a dealer providing this service. Separate disposal of the product will avoid possible negative consequences for the environment and for health resulting from inappropriate disposal, and will enable the constituent materials to be recovered, with significant savings in energy and resources.

get in TOUCH:

TONE Kaffeemaschinen AG
Rheinweg 4
8200 Schaffhausen
Switzerland

+41 52 620 06 06
contact@tone-swiss.com

www.tone-swiss.com

TONE

TONE Kaffeemaschinen AG
Rheinweg 4
8200 Schaffhausen
Switzerland

+41 52 620 06 06
contact@tone-swiss.com
www.tone-swiss.com

